



# **ECF** East Coast Furnitech Public Company Limited

**19 March 2018**

# Presentation Agenda



- Company Overview
- Financial Performance
- Business Strategy
- Q&A

## ECF Stock Overview

Registered Capital

Baht 354.14 million (Including shares for General Mandate and ECF-W2&ECF-W3)

Paid Up Capital

Baht 215.41 million

1<sup>st</sup> Trading Day

26 March 2013

CGR Score



Market Cap. (as of 15 March 2018)

Baht 6,333.17 million (Baht 7.35 per share)

Dividend Policy / Dividend Yield

40% of net profit from Separate financial statements / Year 2016 = 1.76%

## ECF Milestone

**1992** Established the first company of East Coast Group for furniture business

**1998** Started sales to domestic & ELEGA showroom

**2013** ECF was the Listed Company

**2017** Established ECF Power Co.,Ltd. as the subsidiary and started energy business

**1996** Started exporting rubber-wood furniture

**1999** Established ECF and started particle board furniture

**2015** Established ECF Holdings Co.,Ltd. as the subsidiary and started Can Do business

## ECF Business Structure

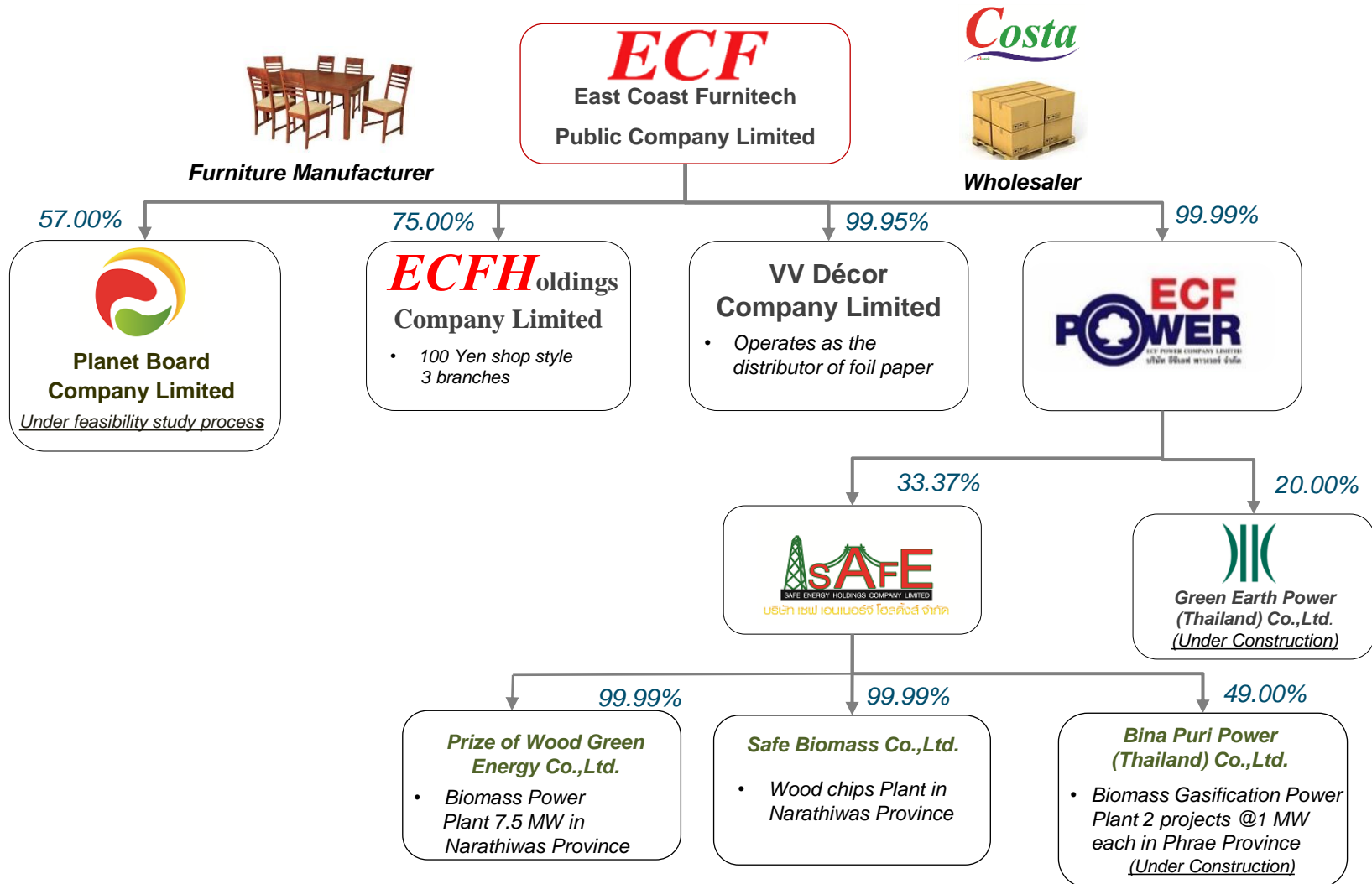

# Company Overview



## verview

The main business of ECF are furniture manufacturer, wholesaler and also distributor both domestic and international in all kinds of furniture and related materials.

### Furniture Products:

- Particle Board
- Rubber Wood
- Showroom & Dealer
- Foil Paper
- Sawn Timber

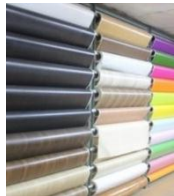

### Company's Brands:



### Main Customers:

Domestic 48%

Oversea 52%

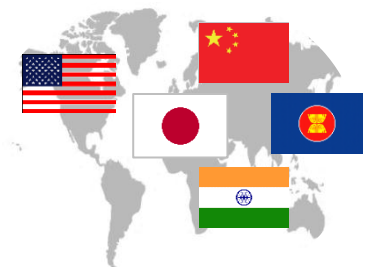

### Other Business

- **Retail Business** 100 Yen shop style, 3 branches

- **Energy Business**
  - Solar Power Plant
  - Biomass Power Plant



## ECF Factory 1

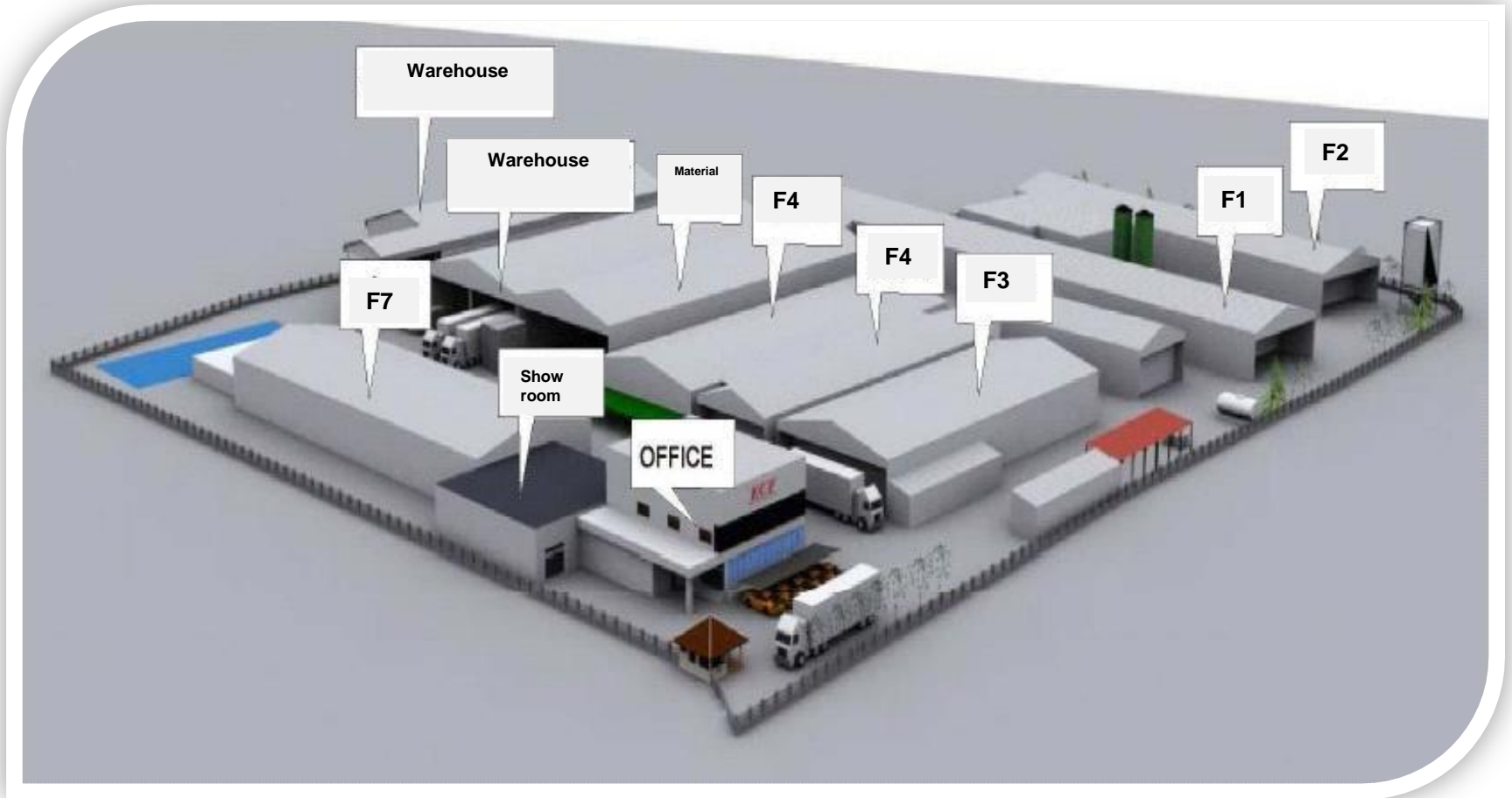

**Klaeng, Rayong**  
**Factory for particle board furniture (Total area 43 rai)**

## ECF Factory 2

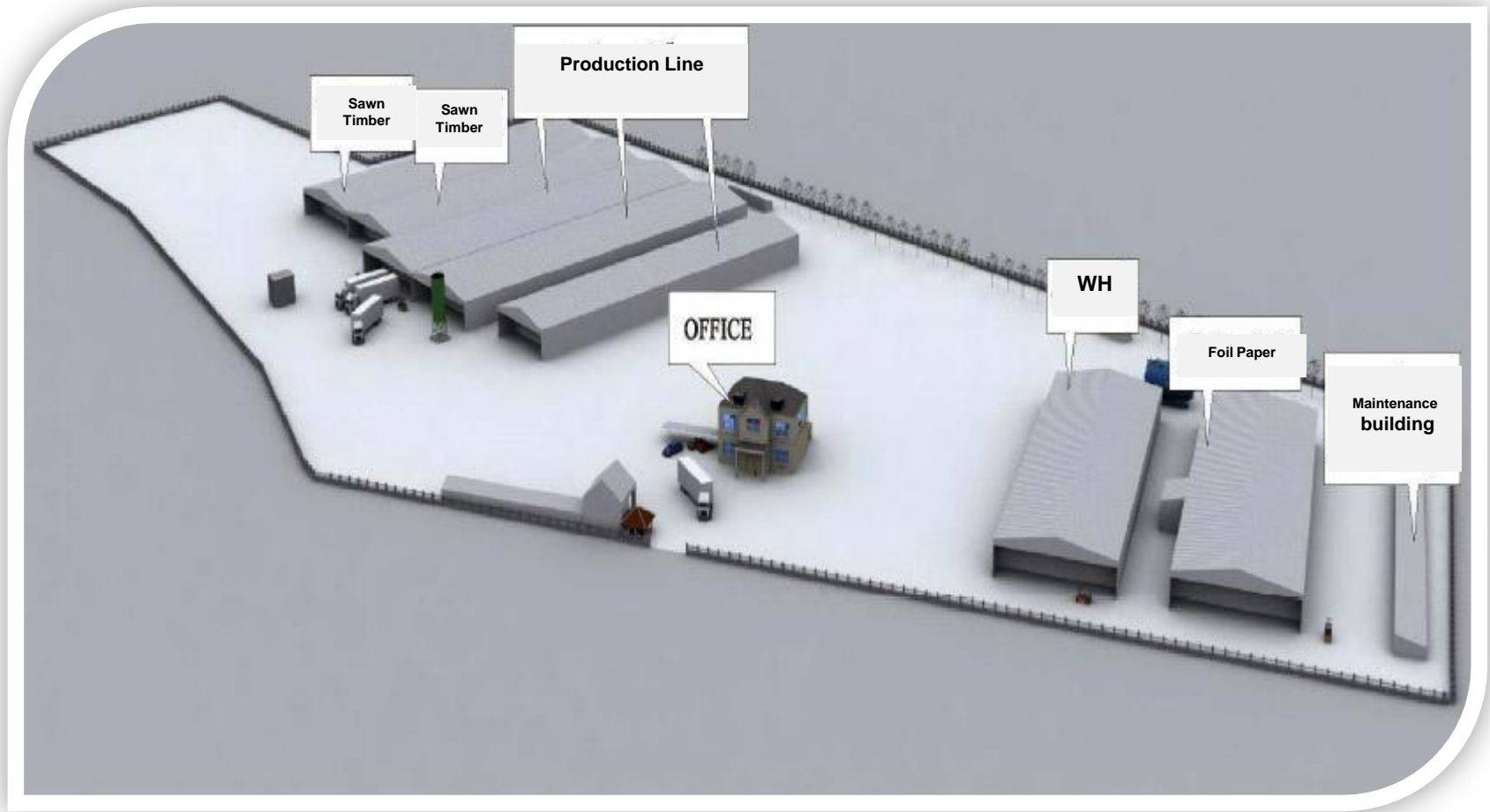

Wangchan, Rayong

Factory for rubber wood furniture and foil paper (Total area 54 rai)



# Presentation Agenda



- Company Overview
- Financial Performance
- Business Strategy
- Q&A

# ECF Business Structure that generating revenue

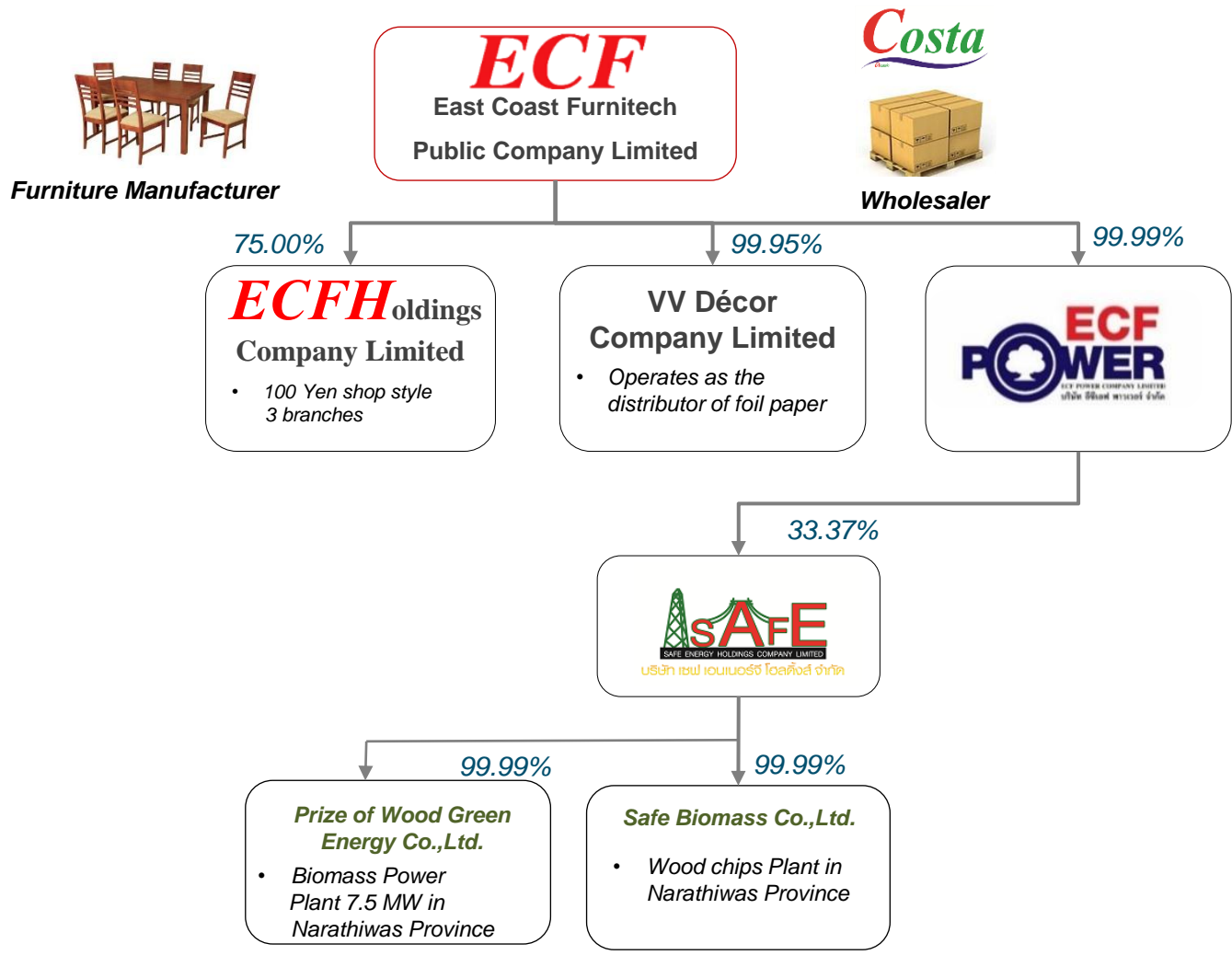

Year 2017 Total Revenue **+6.19% YoY**

**Baht 1,478.68 million**

## Total Revenue

Unit : MB

- ❑ Year 2016 Total Revenue Baht 1,392.49 million
- ❑ Sales Portion Export 52% Domestic 48%
- ❑ Domestic Sales +16%, Baht 690 million
- ❑ Export Sales -3%, Baht 755 million
- ❑ Japan Market -2.10%, Sales Baht 668 million
- ❑ Thailand's Wooden Furniture Export Sales
  - ❑ Year 2017 : -7.82%,
  - ❑ Year 2016 : -4.18%
- ❑ Thailand's Export Sales to Japan Market for Year 2017 : +3.68%

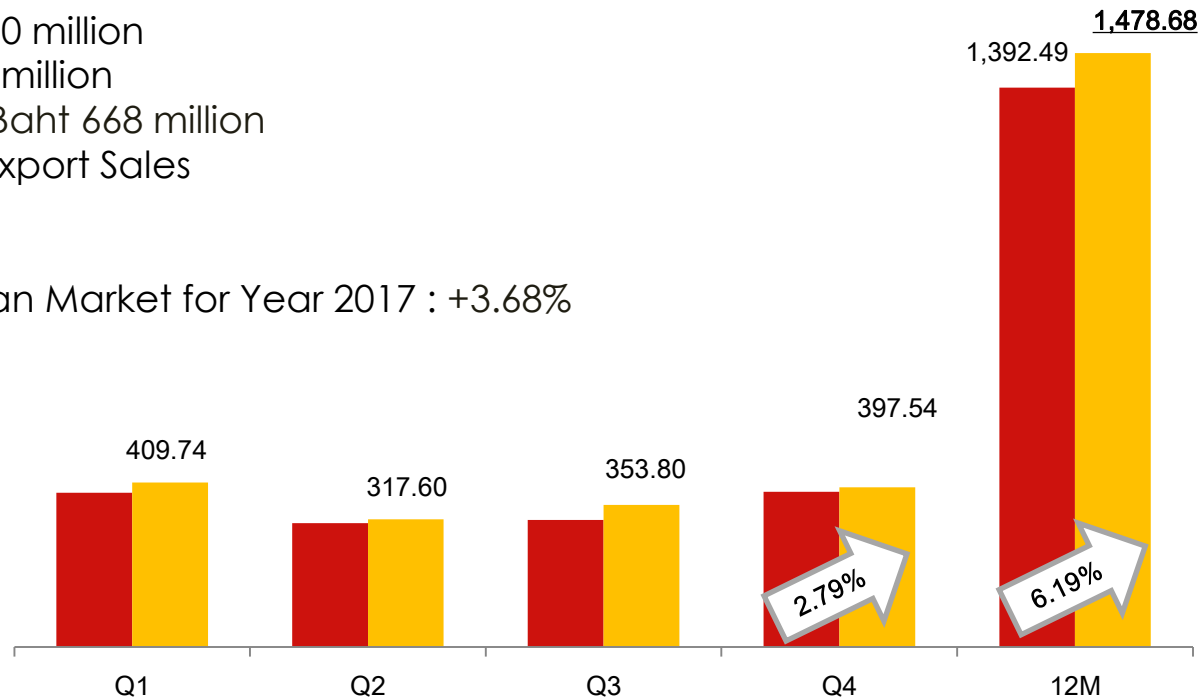

## Net Profit

Furniture Business :

Year 2017 Net Profit **+29.14% YoY**

**Baht 71.49 million**

## Net Profit

Furniture Business + all subsidiaries:

Year 2017 Net Profit (ECF's Portion) **+16.98% YoY**

**Baht 73.05 million**

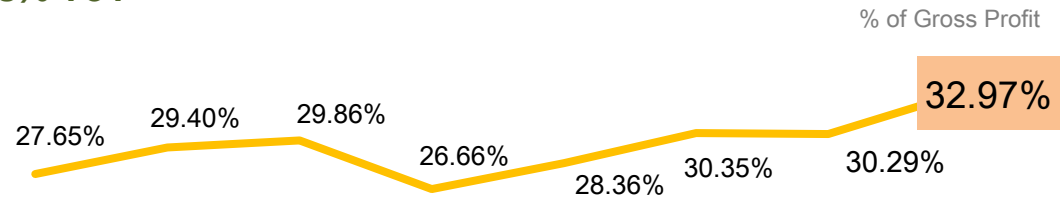
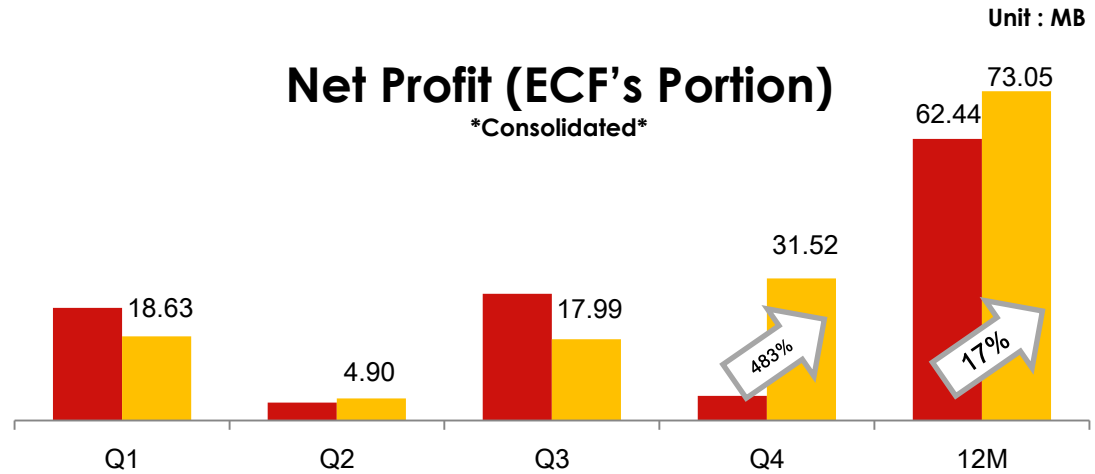

% of Profit for the year 2017, 2016 = 4.51%, 4.66% respectively

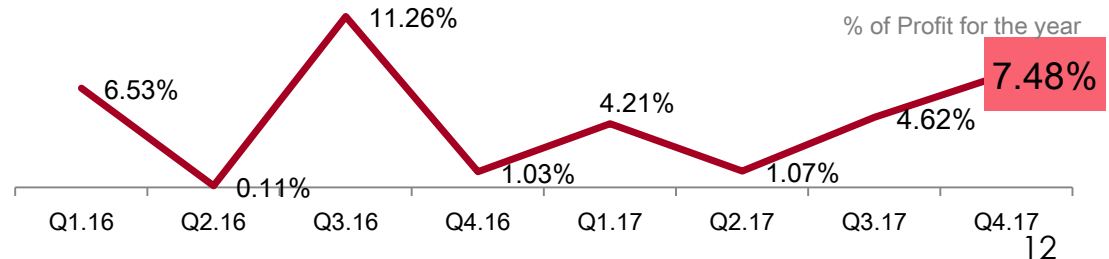

## Cost and Expenses

Comparing to % of total revenue

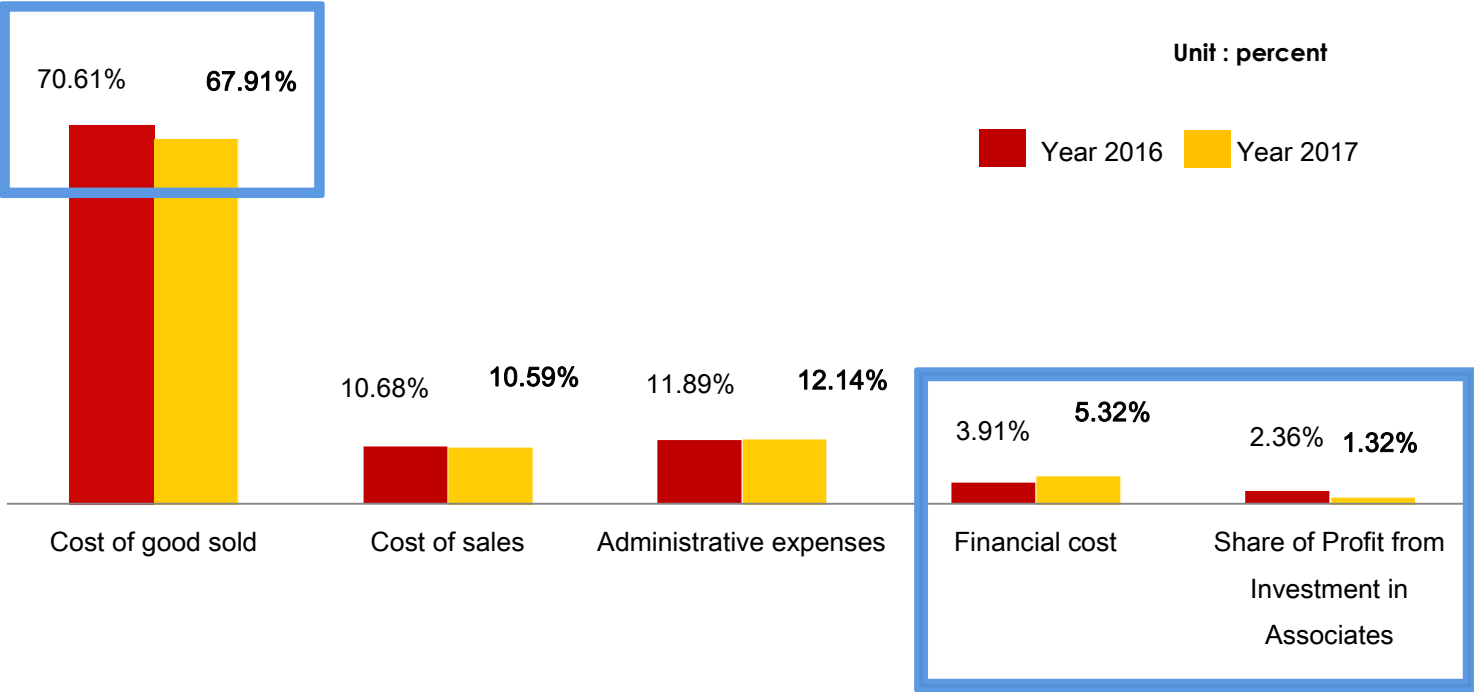

## Sales Revenue categorized by Product Types and Distribution Channels

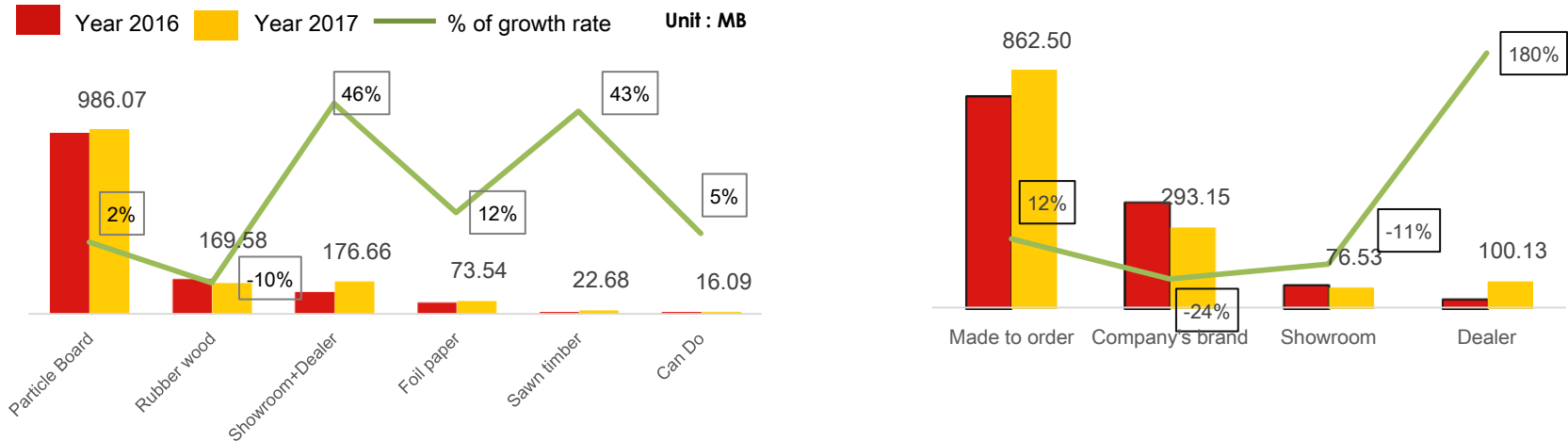

## Financial Position as of 31 December 2017

Unit : MB

| Financial Highlight | 2015            | 2016            | 2017            |
|---------------------|-----------------|-----------------|-----------------|
| <b>Assets</b>       | <b>1,506.20</b> | <b>2,357.28</b> | <b>2,782.77</b> |
| <b>Liabilities</b>  | <b>1,052.54</b> | <b>1,698.19</b> | <b>1,753.73</b> |
| <b>Equity</b>       | <b>453.66</b>   | <b>659.09</b>   | <b>1,029.03</b> |

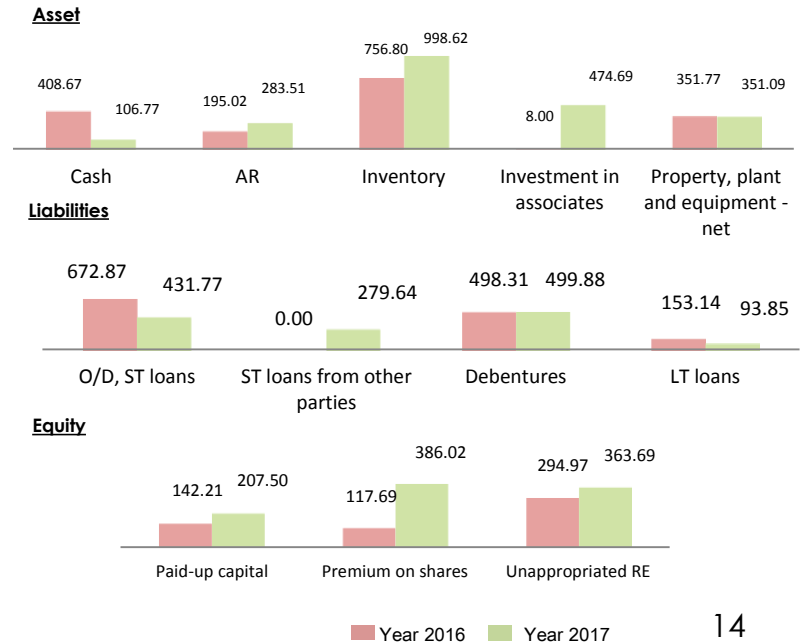

# Presentation Agenda



- Company Overview
- Financial Performance
- Business Strategy
- Q&A

**Established** ECF  
Power for  
Energy business

2016

2017

2018

2019

2020

**Expect** to acquire  
some biomass  
power plants or  
solar power  
plants

**Study** for going  
public of the  
subsidiary or the  
associates

**Started sharing** of  
Profit (loss) from  
investment in the  
associates

On process of  
feasibility study in  
many projects such  
as solar power plants  
and wood-based  
panel factory (Planet  
Board Company  
Limited)

**Expect** to gain  
evidently of profit  
sharing from  
energy business  
and start  
constructing  
wood-based  
panel factories

**Expect** to gain  
evidently of profit  
sharing from  
energy business  
and start  
commercial  
operation of  
Planet Board  
Company Limited

**Expect to gain**  
**Sales revenue**  
**from furniture**  
**business Baht**  
**2,000 million**



## ECF Business Structure



Furniture Manufacturer

**ECF**  
East Coast Furnitech  
Public Company Limited

**Costa**



Wholesaler

57.00%

75.00%

99.95%

99.99%

  
**Planet Board  
Company Limited**  
*Under feasibility study process*

**ECFHoldings  
Company Limited**

- 100 Yen shop style  
3 branches

**VV Décor  
Company Limited**

- Operates as the  
distributor of foil paper

  
**ECF  
POWER**  
ECF POWER COMPANY LIMITED

Future  
Project 1

Future  
Project 2

Future  
Project 3

33.37%

20.00%

  
**SAFE**  
SAFE ENERGY HOLDINGS COMPANY LIMITED  
บริษัท เซฟ เอเนอร์จี้ โฮลดิ้ง จำกัด

  
**Green Earth Power  
(Thailand) Co.,Ltd.**  
*(Under Construction)*

Future  
Project 1

Future  
Project 2

Future  
Project 3

99.99%

99.99%

49.00%

**Prize of Wood Green  
Energy Co.,Ltd.**

- Biomass Power  
Plant 7.5 MW in  
Narathiwat Province

**Safe Biomass Co.,Ltd.**

- Wood chips Plant in  
Narathiwat Province

**Bina Puri Power  
(Thailand) Co.,Ltd.**

- Biomass Gasification Power  
Plant 2 projects @1 MW  
each in Phrae Province  
*(Under Construction)*

## Biomass Power Plant



### Biomass Power Plant 7.5 MW

- Company : Prize of Wood Green Energy Co.,Ltd
- Location : Narathiwat Province
- Invested by : SAFE Energy Holdings Company Limited  
(as ECF Power's associate)
- COD : 27 June 2017

## Wood chips Plant



### Wood Chips Plant

- Project : Wood chips Plant (Full capacity 60 tons/hour but used for PWGE power plant 12.118 tons/hour)
- Company : SAFE Biomass Co.,Ltd.
- Location : Narathiwat Province
- Invested by : SAFE Energy Holdings Company Limited  
(as ECF Power's associate)
- Operating date : 27 June 2017

## Upcoming Projects

### Biomass Power Plant



### Biomass Gasification Power Plant 2 MW

- Project : Biomass Gasification Power Plant 2 MW (divided into 2 projects at 1 MW each)
- Company Bina Puri Power (Thailand) Co.,Ltd
- Location : Phrae Province (Amphur Long & Amphur Soongmen)
- Invested by : SAFE Energy Holdings Company Limited (as ECF Power's associate)
- COD : By April and December 2018 respectively



## Upcoming Projects

### Solar Power Plant



### Minbu Project

- Project : Solar Power Plant 220 MW
- Company : Green Earth Power (Thailand) Co.,Ltd.
- Location : Magway Region, Myanmar
- Invested by : ECF Power (as ECF's subsidiary) at 20% of total shares
- COD : By August 2018



## ECF Park

will be finished by March 2018.



## ECF New Warehouse: Head Office

will be finished by July 2018.

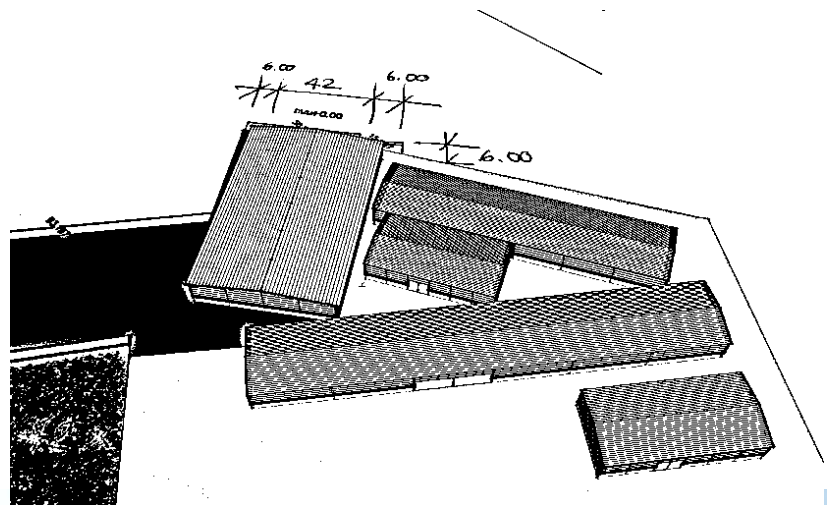

## New Office & Costa Warehouse Lumlukka Klong 5 : 14 rais

will be finished within 2 years.



\*\*For preliminary perspective only



**Wood-based Panel Factory  
Particle Board & MDF  
3-Border Southern Provinces of Thailand**

will be finished within 2 years.



\*\*For preliminary perspective only



# Presentation Agenda



- Company Overview
- Financial Performance
- Business Strategy
- Q&A

**Thank you for your kind attention**

